

Steca Solarix PLI

5000-48

The Steca Solarix PLI is the first product from Steca Elektronik to offer an all-in-one package. It allows users to supply consumers with 230 V AC power, charges the battery with an integrated MPPT charge controller, and at the same time permits connection to a generator or an available electricity grid. Everything in a single device. This means that solar energy can be used as the top priority, for example. And if that isn't enough, a generator can be started or the supply can be switched to the public grid. At the same time, the battery can also be recharged by either the generator or the grid. Given its very quick switchover time of up to 10 ms and its flexible energy priority selection, the Solarix PLI also acts as an uninterruptible power supply. Even difficult consumers, such as large AC motors, can be started reliably with dual overload capacity. The maximum power point tracker in the integrated charge controller ensures that, even in adverse weather conditions, the maximum output is obtained from the PV modules in order to optimally charge the battery and supply the consumers with power at the same time.

Product features

- True sine wave voltage
- High overload capacity
- Integrated MPP tracker
- Multistage charging technology
- Monthly equalisation charge
- Auxiliary contact for starting the generator
- Adjustable cut-off voltages
- Battery type: gel / liquid lead battery
- Lightweight construction
- Easy installation

Electronic protection functions

- Overcharge protection
- Reverse polarity protection of modules, for battery via fuse
- Deep discharge protection
- Short circuit protection of load and module
- Reverse polarity protection by internal fuse
- Reverse current protection at night
- Overtemperature and overload protection
- Acoustic alarm
- PE connection

Displays

- Graphical LCD display
- 3 multi-coloured LEDs show operating states

Operation

- Simple menu-driven operation
- Programming by buttons

Interfaces

- RS-232 serial interface to PC
- Connection to PC via USB

Options

- Interconnectable in parallel or in three phases (extension module required)

Certificates

- Compliant with European Standards (CE)
- RoHS compliant
- Manufactured according to ISO 9001 and ISO 14001

Accessories

- PC software is enclosed

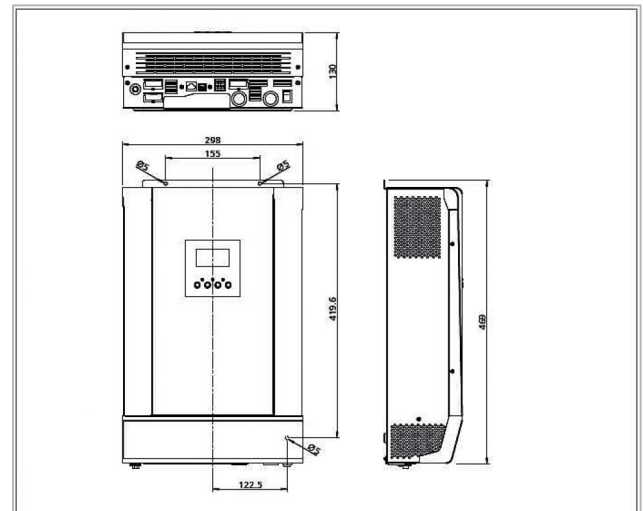
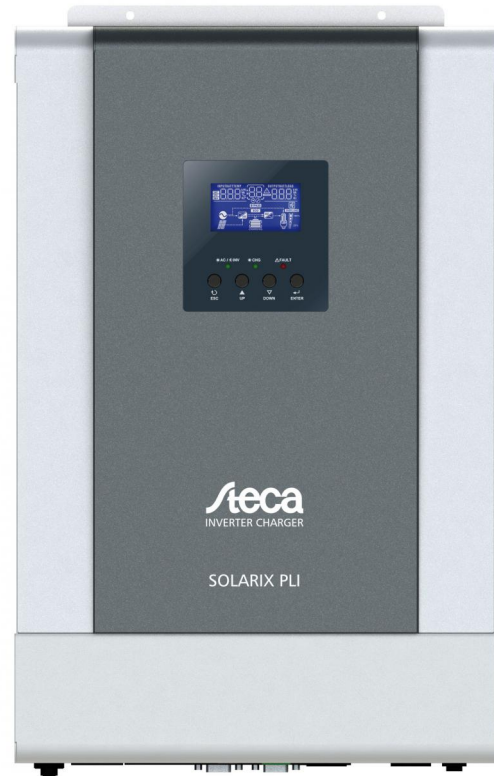

Solar priority with grid connection and/or generator:

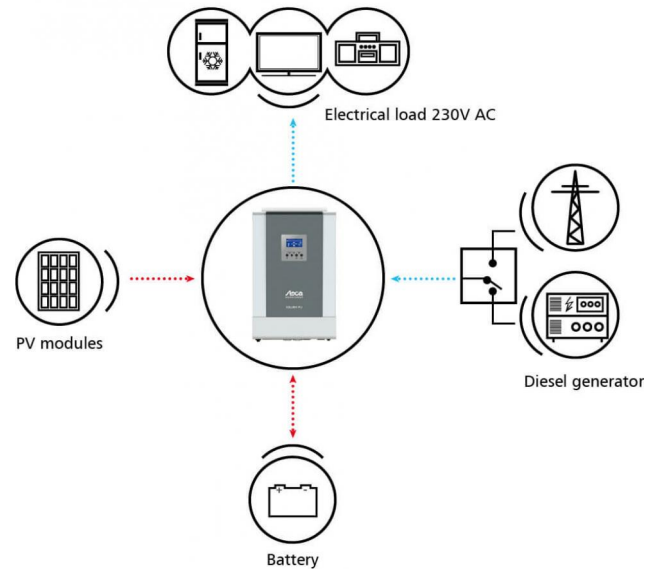

5000-48	
Characterisation of the operating performance	
System voltage	48 V
Continuous power	5000 VA
Power 5 sec.	10000 VA
Max. efficiency sine wave	> 93 %
Max. efficiency charge controller	> 98 %
Own consumption standby	15.0 W
Own consumption ON	50.0 W
Input side	
Input voltage	90 V AC ... 280 V AC
Max. current on transfer system	40 A
Input frequency	40 ... 65 Hz 50 / 60 Hz (automatic detection)
Transfer time	10 ms typical (UPS mode)
AC output side	
Output voltage	230 V AC +/-5 %
Output frequency	50 / 60 Hz
Battery side	
Battery voltage	38.4 V ... 66 V
Max. charge current of PV	80 A
Max. charge current of AC	60 A (programmable)
End of charge voltage	54.0 V (programmable)
Boost charge voltage	56.4 V (programmable)
Equalisation charge	60.0 V (programmable)
Set battery type	liquid (programmable)
DC input side charge controller	
Min. MPP voltage	60 V
Max. MPP voltage	115 V
Min. open circuit voltage solar module / input (at minimum operating temperature)	72 V
Max. open circuit voltage solar module / input (at minimum operating temperature)	145 V
Max. module current	80 A
Nominal charge power	4800 W
Own consumption	< 2 W
Operating conditions	
Operating temperature	0 °C ... + 55 °C
Storage temperature	- 15 °C ... + 60 °C
Rel. humidity	< 95 %, non-condensing
Maximum altitude	2000 a.s.l
Fitting and construction	
Terminal (AC - fine / single wire)	8 mm ² - AWG 8
Terminal (PV - fine / single wire)	12 mm ² - AWG 6
Battery connection (M6 ring terminal included)	35 mm ² ... 50 mm ² AWG 2 ... AWG 0
Double throw signal contact	3 A / 250 V AC (max. 150 W) 3 A / 30 V DC
Degree of protection	IP 21
Dimensions (X x Y x Z)	295 x 468 x 120 mm
Weight	11,5 kg
Cooling principle	fan

- Technical data at 25 °C / 77 °F